

KL-0145-90

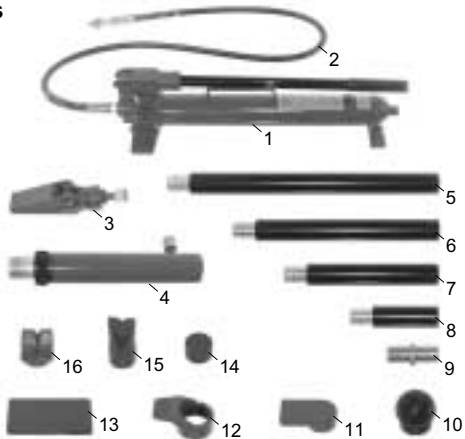

Contents



KL-0145-92

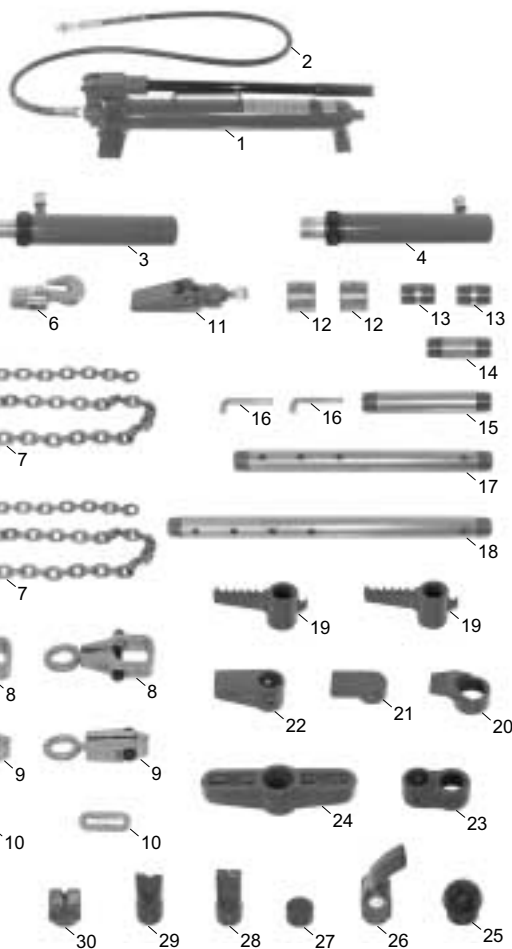

The Hydraulic Set is supplied complete with Storage Trolley.

KL-0145-90 Hydraulic Alignment Set 10 t.

The Hydraulic Press Set **KL-0145-90** allows Pressing and Spreading functions.

Contents:

Part No.	Description	Qty.
1	Hydraulic Hand Pump	1
2	Hydraulic Hose and Connector	1
3	Spreader	1
4	Press cylinder 10 t.	1
5	Extension Tube 530 mm	1
6	Extension Tube 400 mm	1
7	Extension Tube 300 mm	1
8	Extension Tube 170 mm	1
9	Extension Piece	1
10	Plastic Stop Ø 83 mm	1
11	Offset arm for Piston	1
12	Offset arm for Cylinder	1
13	Foot plate	1
14	Press piece flat	1
15	Press piece small prismatic	1
16	Press piece prismatic	1
	Plastic Case	1

KL-0145-92 Hydraulic Alignment Set 10 t.

The Hydraulic Alignment Set **KL-0145-92** allows Press, Pull, Clamp and Spread functions.

Contents:

Part No.	Description	Qty.
1	2 Stage Hydraulic Hand Pump	1
2	Hydraulic Hose and Connector	1
3	Pull cylinder 5 t.	1
4	Press cylinder 10 t.	1
5	Pulling Hooks	1
6	Pulling Hooks	1
7	Pull Chain with one Hook	2
8	Pull Clamp high	2
9	Pull Clamp flat	2
10	Pull Ring	2
11	Spreader	1
12	Threaded Adapter	2
13	Threaded Connector	2
14	Connector Tube 127 mm	1
15	Connector Tube 254 mm	1
16	Pins	2
17	Extension Tube 508 mm	1
18	Extension Tube 635 mm	1
19	Offset arm with Raster	2
20	Offset arm for Cylinder	1
21	Offset arm for Piston	1
22	Offset arm for extension tube	1
23	Adapter for extension tube	1
24	Chain Yoke	1
25	Plastic Stop Ø 83 mm	1
26	Press piece adjustable	1
27	Press piece flat	1
28	Press piece small prismatic	1
29	Press piece conical	1
30	Press piece prismatic	1
31	Foot plate	1
	Trolley	1

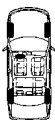

KL-0145-91

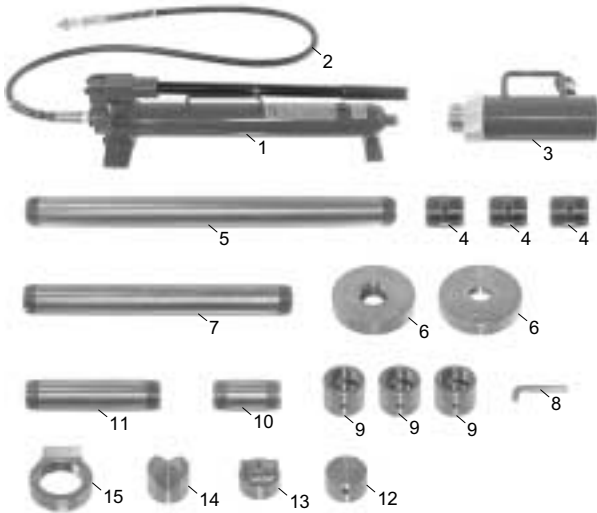

The Hydraulic Set is supplied complete with Storage Trolley.

KL-0145-91 Hydraulic Alignment Set 20 t.

The Hydraulic Press Set **KL-0145-91** allows Pressing function.

Contents:

Part No.	Description	Qty.
1	2 Stage Hydraulic Hand Pump	1
2	Hydraulic Hose and Connector	1
3	Pull cylinder 20 t.	1
4	Threaded Connector	3
5	Extension Tube 710mm	1
6	Press disc	2
7	Extension Tube 510 mm	1
8	Pins	1
9	Threaded Adapter	3
10	Connector Tube 130 mm	1
11	Connector Tube 255 mm	1
12	Press piece flat	1
13	Press piece conical	1
14	Press piece prismatic	1
15	Offset arm for Cylinder	1
	Trolley (without illustration)	1

KL-0049-31 with Adapter 2 1/4" UNS to M18



KL-0049-31 Slide Hammer

For axles, drive shafts, wheel hubs, brake discs and brake drums, etc. inclusive Adaptor 2 1/4" UNS to M18.

Slide weight:.....4,8 kg

Length:..... 690 mm

KL-0049-3020



KL-0049-3020 Hook

For the Slide Hammer **KL-0049-31**.

KL-0190-90

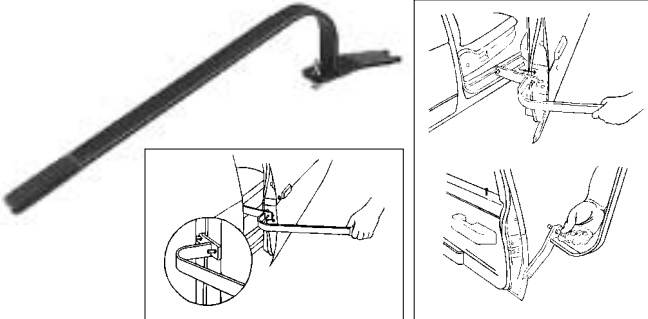

KL-0190-90 Door Adjuster

Adjusts door hinges on most cars and light trucks.

Will adjust doors with either bolted or welded hinges.

Weight:..... 2,33 kg

Special body grip wrenches

137 K1



137 K2



137 K3



Special body grip wrenches

137 K1 Special body grip wrench

With adjusting screw and dip-insulated release lever (blue).

137 K2 Special body grip wrench

With adjusting screw and dip-insulated release lever (blue). Special jaws with domed clamping surfaces, 25 x 20 mm at top, 7 x 7 mm at bottom.

137 K3 Special body grip wrench

With adjusting screw and dip-insulated release lever (blue). Special jaws with flat clamping surfaces, 40 x 14 mm at top, 40 x 35 mm at bottom.

Note:

Further Pliers and Tools see **GEDORE Catalog**.

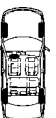

KL-0190-6



Opel, Ford,
Peugeot, Citroën

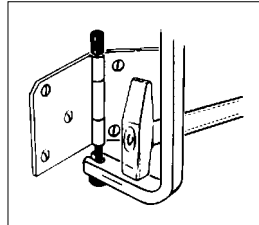

Spare Parts:

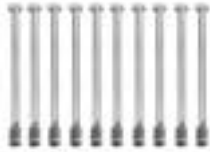

KL-0270-3 B

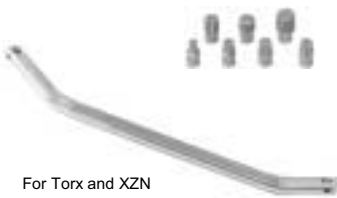

VW-Audi
Mercedes



For Torx and XZN

KL-0270-31 B

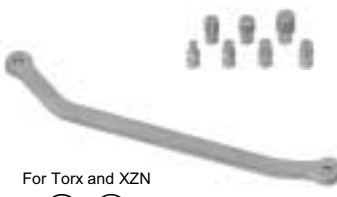

VW-Audi
Mercedes



For Torx and XZN

KL-0120-80



Universal



KL-0190-6 Slide Yoke

For removal and replacement of door hinge pins.
Application: Opel/Vauxhall, Ford, Peugeot, Citroën.

Consists of:

KL-0190-60 Slide Yoke

Without pulling bolts.

KL-0190-61 Pulling Bolts Ø 5 mm (10 Pcs.) Length:..... 110 mm
Application: Opel/Vauxhall, Ford, Peugeot, Citroën. etc.

KL-0190-62 Pulling Bolts Ø 3.5 mm (10 Pcs.) Length:..... 110 mm
Application: Ford, Citroën, etc.

KL-0190-63 Pulling Bolts Ø 5 mm (10 Pcs.) Length:.....120 mm
Application: Renault, etc.

KL-0270-3 B Angle Driver with 7 Inserts

Suitable for Door Hinge Bolts

e.g. Audi 1997 -onwards; Renault Safrane / Laguna; Seat Arosa / Cordoba / Ibiza; VW Golf III / Golf IV / Passat 1997 -onwards/ Polo / Vento; Škoda etc.

To quickly and easily loosen and tighten the bolts in door hinges.

suitable for Mercedes Toe Adjustment

e.g. 190 Series (W201), C Class (W202), C Class (W203), 200 - 300 E (W124), E Class (W210), S Class (W220)

To adjust the Toe Angle on the rear axle. The special form allows easy and precise adjustment of the inaccessible adjusting bolt.

Technical Data:

Insert with 5/16" Drive:

T30, T40, T45, T50, XZN-8, XZN-10, XZN-12

Socket Length:.....310 mm

Weight:430 g

Drive: 5/16"

Accessory:

KL-0270-303 7-piece Insert Set

consists of 5/16" Inserts with sizes:

T30, T40, T45, T50, XZN-8, XZN-10, XZN-12

KL-0270-31 B Angle Driver with 7 Inserts

As KL-0270-3 B

however in forged design.

Suitable for Mercedes Toe Adjustment

e.g. 190 Series (W201), C-Class (W202), C-Class (W203), 200 - 300 E (W124), E-Class (W210), S-Class (W220)

Due to its special form, this tool allows easy and precise adjustments to the inaccessible adjustment bolts.

Technical Data:

Size 5/16" Bit-Inserts:..... T30, T40, T45, T50, XZN-8, XZN-10, XZN-12

Length:.....320 mm

Weight:520 g

Bit-Drive: 5/16"

Accessory:

KL-0270-303 7-piece Insert Set.

KL-0120-80 Tank Sender Spanner Set adjustable

Universal application.

For removing and replacing the Plastic Retaining Ring on the Sender Unit on Fuel Tanks.

Consists of:

KL-0120-801 Tank Sender Spanner Ø80 mm - Ø120 mm

Range:80 - 120 mm

Drive: hex 24 mm

KL-0120-802 Tank Sender Spanner Ø110 mm - Ø170 mm

Range: 110 - 170 mm

Drive: hex 24 mm

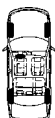

KL-0198-90 KB



Contents:

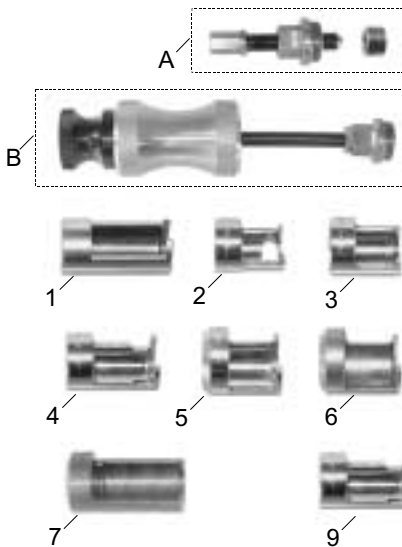

KL-0126-33



KL-0198-90 KB Wiper-Arm Puller Set (German Utility Model)

Suitable for: **VW-Audi, BMW, Citroën Ford, Mercedes, Opel/Vauxhall, Peugeot, Renault etc.**

The first universal Puller Set to remove bolted Windscreen Wiper Arms, especially for those which have become rusted or corroded onto the drive-shaft.

Stubborn and deep-seated Wiper Arms may be quickly and easily removed using the **KL-0198-90** Puller Set.

Wiper Arms with integrated Screen-Wash nozzles - e.g. VW-Audi, BMW etc. on the rear window - can be easily removed by using the Slide hammer included in the Set.

Wiper Arms with central holes may be removed by using the Pressure Spindle. Those Wiper Arms with no central hole require the Pressure Bolt to be used with the Pressure Adaptor supplied.

Contents:

Pos.	Part No.	Description	Qty.
	KL-0198-90 KB	Wiper Arm Puller Set	1
	<i>consists of:</i>		
A	KL-0198-9008	Pressure Spindle	1
B	KL-0198-9009	Slide Hammer	1
1	KL-0198-901	Fork 1	1
2	KL-0198-902	Fork 2	1
3	KL-0198-903	Fork 3	1
4	KL-0198-904	Fork 4	1
5	KL-0198-905	Fork 5	1
6	KL-0198-906	Fork 6	1
7	KL-0198-907	Fork 7 (BMW etc.)	1
9	KL-0198-909	Fork 9 (Golf V rear window wiper etc.)	1
	KL-0198-9090	Plastic Storage Case (empty)	1

Wiper Arm Puller Set:

KL-0198-921	Puller Set BMW (consists of: Pos. 1, 4, 6, 7, A) Suitable for: 3 series Compact (E36) from '94, Z3, 3 series (E46) 1999 onwards, 5 series (E39) 1996 onwards
KL-0198-922	Puller Set Citroën (consists of: Pos. 1, 2, 3, 4, 5, A, B) Suitable for: Berlingo, C5, Evasion, Saxo, Xsara, Xsara Picasso
KL-0198-923 A	Puller Set VW-Audi, Ford (consists of: Pos. 1, 3, 4, 5, 6, 9, A, B) Suitable for: Audi 80 (from 1986 - '96), A3, A4 (up to 2001), A4 (2001 onwards), A6 (from 1997 - '01) Ford Fiesta (from 1995), Focus, Ka, Mondeo (up to 2001), Mondeo (from 2001), Galaxy (up to 2000), Galaxy (up to 2000) VW Polo (up to '99), Polo ('99 onwards); Lupo, Golf III, Golf IV, Golf V, Sharan (2000 onwards), Passat (up to 2000), Passat (2001 onwards), Beetle
KL-0198-924	Puller Set Mercedes (consists of: Pos. 3, 4, 5, A) Suitable for: A Class, C Class (W203), Vito/ V Class, M Class, E Class (W210)
KL-0198-925	Puller Set Opel/Vauxhall (consists of: Pos. 1, 4, A) Suitable for: Corsa B, Corsa C, Astra F, Astra G, Astra G Kombi, Zafira
KL-0198-926	Puller Set Peugeot (consists of: Pos. 2, 4, 5, A) Suitable for: 106, 206, 306, 306 Cabrio, 307, 406, 605, Partner
KL-0198-927	Puller Set Renault (consists of: Pos. 4, 5, A) Suitable for: Clio ('98 onwards), Space ('96 onwards), Kangoo, Laguna, Laguna Estate, Mégane ('99 onwards), Mégane Limousine, Scénic, Twingo



KL-0126-33 Screen Washer Jet Needle Tool

The Screen-Washer Jet tool allows cleaning of blocked jets and accurate adjustment of spray-direction of all screen-washer jets.

Weight: 40 g

KL-0126-205



KL-0126-205 Magnetic Lifter Telescope with Scribing Iron

Universal application in handy form for pocket storage.

With a strong magnetic head with 7,5 mm Ø providing a lifting force of 300 g. Extendable to a total length of 670 mm, collapsed length only 155 mm. the Scribe may also be used to adjust the aim of screen-wash nozzles.

KL-0570-20



BMW

KL-0570-20 Special Torx® Socket T80

Necessary for removal and replacement of the windscreen wiper arm and adjusting the pressure on **BMW E31, E38 and E39**.

This special Torx® nut is mounted within the wiper arm bearing assembly.

Drive:..... 1/2"ø

KL-1601



Fiat, Lancia



KL-1601 Spanner for Castellated Nuts

For removal and replacement of exterior mirrors on **Fiat and Lancia** cars.

Length:.....220 mm

KL-4306-6330



BMW

KL-4306-6330 T-Handle Screwdriver Torx® T30

For the front mudguard fixing bolts on BMW 7 series (E38).

This tool is required to allow the front mudguards to be removed and replaced without the need to remove the front doors. The long, slim form of the tool allows the recessed Torx® Bolts in the A-post to be removed and replaced through the door-opening.

For removal and replacement of Audi A6 Headlamps.

The long, slim form of this T-handle allows the Torx® Bolts on the headlamps to be quickly and easily reached.

Length:.....350 mm

KL-4305-6225



VW

KL-4305-6225 Screwdriver Torx® T25

For removal and replacement of VW Sharan Headlamps from 2000.

The long, slim form of this Screwdriver allows the Torx® -Bolts on the headlamps to be quickly and easily reached.

Length:.....300 mm

Weight:70 g

KL-0271-1

VW-Audi



KL-0271-1 Headlamp Adjusting Tool

For **VW Golf III and Vento**.

Length:.....300 mm

KL-0270-2

VW-Audi



KL-0270-2 Screwdriver XZN M4

Application: For door handle **VW Passat from 96 onward and Golf IV**.

KL-0272-10



VW, Ford, Seat



KL-0272-10 Slotted-Nut Spanner Set (3 pcs.)

For: VW Polo, Sharan; Ford Galaxy; Seat Alhambra.

For quick and easy removal and replacement of the Slotted-Nut retaining the multi-pin electric socket on the door-pillar.

Required when the door needs to be removed.

Size	Application examples
Size 1	VW Polo front door VW Sharan, Ford Galaxy, Seat Alhambra rear door
Size 2	VW Sharan, Ford Galaxy, Seat Alhambra up to 2000 front door
Size 3	VW Sharan, Ford Galaxy, Seat Alhambra from 2001 front door

® = reg. trademark of Camcar-Textron Inc. USA

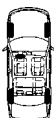

KL-4305-6220

Mercedes



KL-0375-10

Mercedes
W203

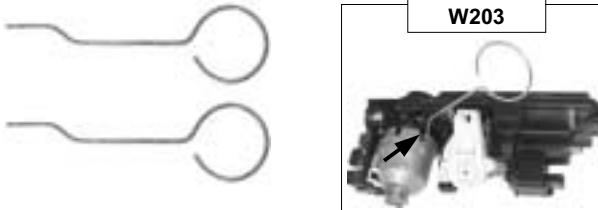

KL-0374-30

Mercedes
W210

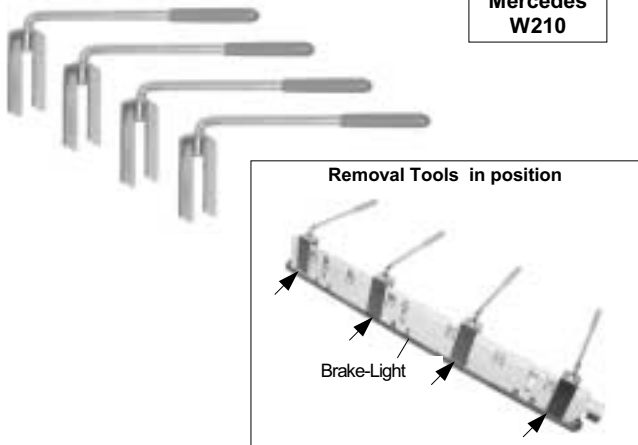

KL-0374-1

Mercedes

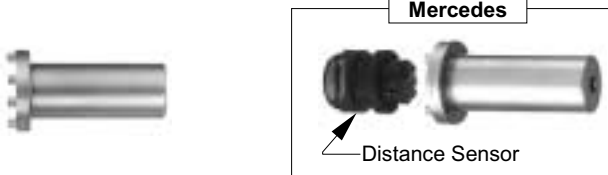

KL-0192-22

Mercedes



KL-0192-24



KL-0192-25



KL-4305-6220 Screwdriver Torx® T20

For removing and replacing the door handle Mercedes A Class and C Class.

The long, slim form of this Screwdriver allows the Torx® -Bolts on the door handle to be quickly and easily reached.

Length: 300 mm

Weight: 60 g

KL-0375-10 Needle Set for Tail Gate Lock

For Mercedes C Class (W203) Tail gate lock.

For quick and easy removal of the Locking Cylinder from the Tail gate Lock mechanism.

The Set consists of 2 Pins made from stainless steel (V2A).

KL-0374-30 Removal Tool Set (4 pcs.)

For Mercedes E Class (W210) Estate Car.

Required to remove the high-level brake-light from the tail-gate. All four retaining clips must be held open using the 4 piece removal tool set.

Failure to use these tools will result in damage to the mounting and the brake-light.

KL-0374-1 Toothed Socket for Distance Sensor

For removal and replacement of the Distance Sensor which is built-in to the rear bumpers of Mercedes S Class (W140) and E Class (W210).

Not only for removal and replacement, but also for mounting the Distance Sensor with the correct tightening torque.

Drive:3/8"ø

Length: 135 mm

KL-0192-22 Safety Clip Pliers

Suitable for all Audi A3, VW Golf IV with Petrol engines

To release the fuel line unions. Needed for example when the fuel filter is changed.

Suitable for Mercedes W124, W140 and W202.

For installing retaining clips to secure the chrome strip on the bumper of the Mercedes W124, W140 and W202.

Therefore, the pliers is equipped with special clip retaining notches.

Length: .. 210 mm

Weight: 200 g

KL-0192-24 Flat Pliers

With extra long grip, for difficult to get to positions.

Length: 280 mm

KL-0192-25 Flat Pliers 45°

With extra long grip, angled 45°, for difficult to get to positions.

Length: 280 mm



KL-0190-10

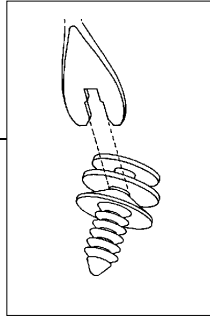

KL-0190-10 Door Upholstery Remover

For removal of door inner-linings.

Weight:200 g

KL-0190-4



KL-0190-4 Upholstery Pliers

Universal.

For removal of door inner-linings and other trim items held in place by plastic rivets.

KL-0190-41

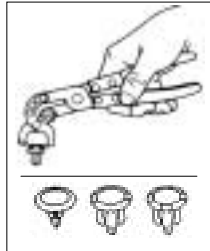

KL-0190-41 Rivet Removal Pliers

With 90° rotating head.

To remove 2-part re-usable plastic rivets - examples: on Trim or inner door facings.

By lifting the central spreader pin with the Pliers **KL-0190-41** the Plastic Rivet may be withdrawn.

KL-0190-7

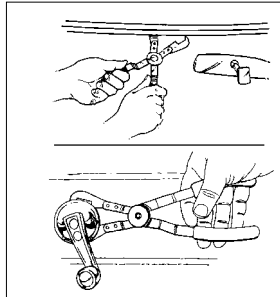

KL-0190-7 Windscreen Moulding / Door Handle Clip Pliers

For removal and replacement of the Ω Retaining Clips on Sun Visors, Rear-view Mirrors and Window-winders, etc.

This tool is applicable to most vehicles.

The tool prevents damage to Visors, Head-linings, Door-linings, etc.

KL-0190-81

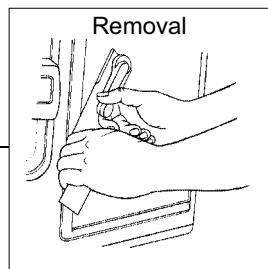
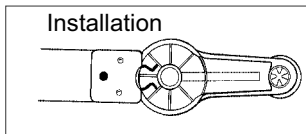

KL-0190-81 Window and Door Clip Remover/Installer

For removal and replacement of the Ω Retaining Clips on Door-handles, Window-winders, etc.

This tool is applicable to most vehicles.

The tool prevents damage to Visors, Head-linings, Door-linings, etc.

Weight:140 g

KL-0190-82



KL-0190-82 Door Handle Clip Remover

To remove and replace the Ω-Retaining Clips found on Door handles, Window Winders, etc.

Application: For almost all passenger cars.

KL-0194-100

KL-0194-10



KL-0194-11



KL-0194-12



KL-0194-100 Nylon Lever Set

The Nylon Lever Sets allows the easy removal of ornamental ledges, door covering, windscreen rubber, etc.

Because the lever sets are made of nylon no damage is caused when used on glass, paintwork and door covers.

Specification / Technical Data:

Part No	Description	Measures [mm]	Weight [g]
KL-0194-100	Nylon Lever Set		
<i>consists of:</i>			
KL-0194-10	Nylon Mount Wedge	200 × 26 × 26	100
KL-0194-11	Nylon Mount Lever	Length: 201	15
KL-0194-12	Nylon Mount Lever	Length: 202	25

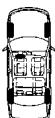

KL-0194-130

KL-0194-13



KL-0194-14



KL-0194-15



KL-0194-16



KL-0194-130 Set of plastic wedges (4 pcs.)

The four plastic wedges are particularly suitable for body work such as removing and installing trim strips, door trims, door clips etc.

Contents / Technical Data:

Part-No.	Description	Measures [mm] L x B x H	Weight [g]
KL-0194-130	Set of plastic wedges		250
<i>consists of:</i>			
KL-0194-13	Plastic wedge with felt	255 x 20 x 25	75
KL-0194-14	Plastic wedge with straight and angled tip	250 x 20 x 10	35
KL-0194-15	Plastic wedge	200 x 30 x 25	75
KL-0194-16	Plastic wedge angled with cutout and pin (for door clips).	230 x 22 x 8	55

KL-0190-50



KL-0194-131 Set of plastic wedges (3 pcs.)

As **KL-0194-130** but consists of **KL-0194-13**, **KL-0194-14** and **KL-0194-15**.

KL-0190-50 Hog Ring Pliers Set

For closing Hog Rings to repair passenger car seats (various manufacturers).

Size:220 x 115 x 33 mm

Weight:..... 500 g

Contents:

Part No.	Description	Qty
KL-0190-50	Hog Ring Pliers Set	1
<i>consists of:</i>		
KL-0190-5	Hog Ring Pliers	1
KL-0190-501	Hog Rings (100 Pcs)	1
	Plastic Storage Case	1

KL-0470-10

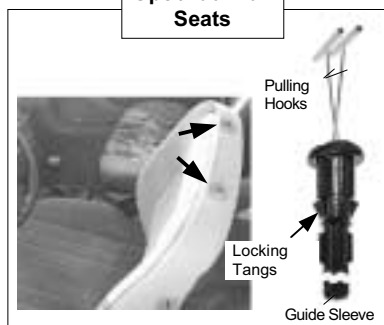

KL-0470-10 Hook Set

Suitable for Opel/Vauxhall Astra, Corsa, Frontera, Omega, Tigra, Vectra, Zafira

To allow the removal of the Head Support columns in the seat-back to be removed without the need to dismantle the upholstery, it is necessary to depress the inner locking tangs using **KL-0470-10** Hook Set.

Length: 166 mm

Weight: 42 g

KL-0194-41

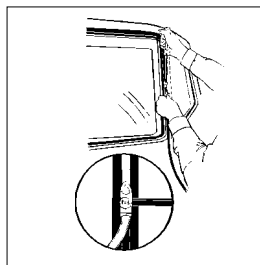

KL-0194-41 Windscreen Locking Strip Tool

Two Double-Ended Tips to Fit Most Applications.

Just select the tip with opening that most closely fits locking strip and then feed locking strip into eyelet.

Weight: 170 g



KL-0194-27



KL-0194-273

Square cut wire 50 m



KL-0194-27 Cutting Wire Tool Set

For cutting glued glass panes.

Consists of :

2 self sticking handle grips, 50 m of wire, 1 needle with eyelet, 1 wooden case (275x145x38mm)

Weight: 800 g

KL-0198-10

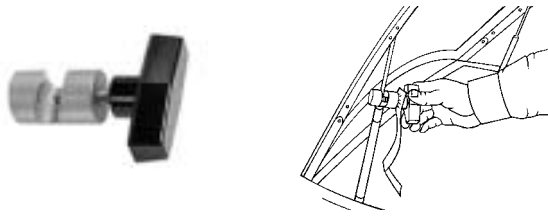

KL-0198-10 Universal Lift Support Clamp

Holds Weak Gas Charged Lift Supports Open.

Clamp securely holds weak lift supports in the extended position to allow access to the engine compartment or luggage area. A colourful flag serves as a reminder to remove the clamp before closing.

Weight: 170 g

KL-0191-1



KL-0191-1 Gasket Scraper - Small

For cleaning of sealing faces especially at narrow space conditions, due to short design. Quenched and tempered blade.

Length: 180 mm

Blade width: 24 mm

KL-0191-2



KL-0191-2 Gasket Scraper

For cleaning of sealing faces on engine, gearbox etc. Long design. Quenched and tempered blade.

Length: 245 mm

Blade width: 24 mm

KL-0191-3



KL-0191-3 Gasket Scraper - Large

For cleaning of sealing faces, large design. This tool is also applicable for removal of under body sealant.

Length: 180 mm

Blade width: 32 mm

KL-0191-61



KL-0191-61 Gasket Scraper

For removing stickers from windscreens, bumpers etc.

Length: 165 mm

Blade width: 40 mm

Weight: 200 g

Spare part:

KL-0191-611 Stainless steel blade set (10 Pcs.)

KL-0157-2



KL-0157-2 Twin-Arm Battery-terminal puller

The perfect tool for removing small parts such as battery terminals, pulleys, wheels, ball bearings, etc. The hook tips grip automatically.

Part-No:	ó [mm]	ô [mm]	Load max.	Weight [kg]
KL-0157-2	60	40	0,5 t.	0,3

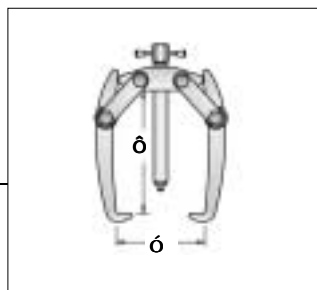

KL-0157-1



KL-0157-1 Twin-Arm Battery-terminal puller

The perfect tool for removing small parts such as battery terminals, pulleys, wheels, ball bearings, etc. The hook tips grip automatically.

Part-No:	ó [mm]	ô [mm]	Load max.	Weight [kg]
KL-0157-1	60	60	0,5 t.	0,3

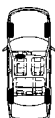

KL-0196-20

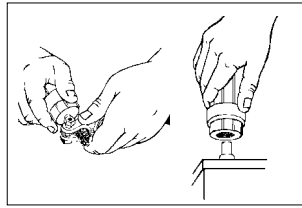

KL-0196-20 Battery Brush

Cleans dirt and corrosion from battery terminals and cable clamps. The external brush cleans cable clamps and the internal brush cleans terminal posts. Case is made of high impact plastic that will not weaken in cleaning solutions.

Weight:..... 60 g

KL-0196-21

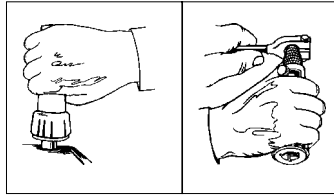

KL-0196-21 Adjustable Battery Post and Terminal Cleaner

Three Post Cleaning Settings.

Floating stainless steel blades fit all standard posts, positive and negative. Cleans terminal clamps with knurled, stainless steel coiled wire.

Weight:..... 115 g

KL-0190-23

KL-0190-24

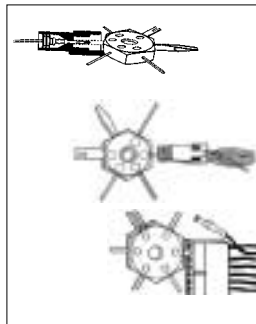
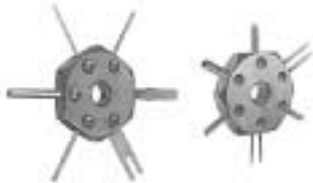

Terminal Tools

Eliminate Damaged Wires and Terminals.

Designed to remove wires from terminals without damage to either.

KL-0190-23 Wire Terminal Tool

Designed for Pack-Con and Weather-Pack terminals on GM C3 Systems. Tool can also retrieve trouble codes from engine computer on late model GM vehicles.

Weight:..... 60 g

KL-0190-24 Wire Terminal Tool

Prongs depress the "barbs" on conventional terminals.

Weight:..... 60 g

KL-0190-20



KL-0190-20 Bulb Pliers (universal)

Application: **VW-Audi, Opel/Vauxhall, Ford, Mercedes, BMW.**

For quick and easy removal of bulbs from dashboards etc.

KL-0190-21



KL-0190-21 Bulb Pliers (universal)

For the removal of small light bulbs (Ø 4-6 mm) from dashboards etc.

Length: 135 mm

Weight:..... 78 g

KL-0190-3



KL-0190-3 Relay Pliers - Angled 70°

For removal and installation of stubborn relays in narrow space conditions.

Applicable on **VW/Audi, BMW, Ford, Mercedes, Opel/Vauxhall etc.**



KL-0190-37

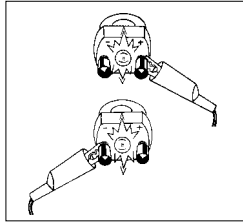

KL-0190-37 Power / Ground Outlet

Provides a Convenient Electrical Ground and Power Source from the Vehicle.

Plug the tool in to a cigarette lighter or power accessory receptacle. You now have a ground and power source on the dash.

Weight:60 g

KL-0190-30

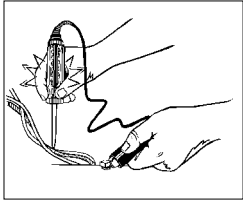

KL-0190-30 Pilot Lamp

The Test lamp allows checking of connections and cables up to 24 volts DC. Locates short-circuits and open-circuits.

The probe-tip is protected by a screw-cap.

Weight:60 g

KL-0190-32

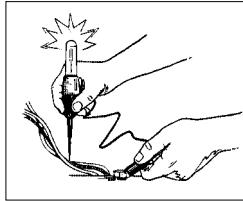

KL-0190-32 Pilot Lamp

Quick check both AC and DC current up to 28 volts with power on. Helps locate shorts or breaks in wiring. Complete with insulated grounding clip.

Weight:85 g

KL-0190-33

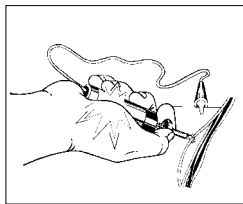

KL-0190-33 Pilot Lamp

Hooded probe protects your fingers and automatically centers the wire. Quickly test low voltage up to 28 volts.

The special construction allows the tester to be used in difficult-to-reach places where its ability to clamp onto the conductor to be tested allows its use with one hand.

The spring-hook at the end ensures that the conductor is held in the right position, and also acts as a protection against injury.

Weight:85 g

KL-0190-34

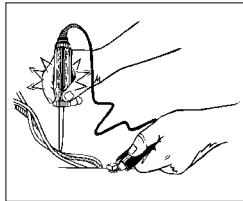

KL-0190-34 Pilot Lamp

Quickly Tests Low Voltage up to 28 Volts.

The probe, handle, cord and clamp are reinforced for extra durability.

Weight:170 g

KL-0190-35

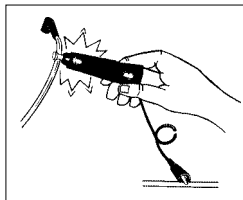

KL-0190-35 Pilot Lamp

Checks Both Low Voltage and Spark Plug Wires.

The low - side checks AC and DC current up to 28 volts with power on. The high - side checks spark plug wires without piercing. Complete with insulated clip.

Weight:85 g

KL-0190-36

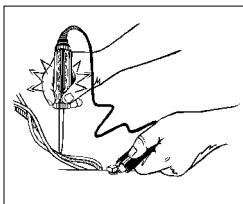

KL-0190-36 Pilot Lamp

The test lamp is ideal for a rapid check on 3 - 20 Volt power lines and for determining the polarity.

Red light means + (positive),

Green light means - (negative) polarity

Can also be used for low currents from 21 mA.

Weight:115 g

